Keyboards (101- and 102-Key)

Description	1
Keyboard Layouts	1
101-Key Keyboard	2
102-Key Keyboard	3
Belgian Keyboard	4
Canadian French Keyboard	5
Danish Keyboard	6
Dutch Keyboard	7
French Keyboard	8
German Keyboard	9
Italian Keyboard	10
Latin American Keyboard	11
Norwegian Keyboard	12
Portuguese Keyboard	13
Spanish Keyboard	14
Swedish Keyboard	15
Swiss Keyboard	16
U.K. English Keyboard	17
U.S. English Keyboard	18
Sequential Key-Code Scanning	19
Buffer	19
Keys	19
Power-On Routine	20
Power-On Reset (POR)	20
Basic Assurance Test	20
Commands from the System	21
Commands to the System	26
Scan Codes	27
Set 1 Scan-Code Tables	27
Set 2 Scan-Code Tables	30
Set 3 Scan Code Tables	34
Clock and Data Signals	37
Data Stream	37
Data Output	38
Data Input	39
Encode and Usage	40
Extended Functions	43
Shift States	45
Special Handling	47
System Reset	47
Break	47
Pause	47

Print Screen	47
System Request	48
Other Characteristics	48
Cables and Connectors	49
Specifications	50

Figures

1.	Keyboard Commands from the System	21
2.	Set All Keys Commands	23
3.	Set Key Type Commands	23
4.	Set/Reset Status Indicators	24
5.	Typematic Rate	25
6.	Keyboard Commands to the System	26
7.	Keyboard Scan Codes, Set 1	28
8.	Keyboard Scan Codes, Set 1	29
9.	Keyboard Scan Codes, Set 1	30
10.	Keyboard Scan Codes, Set 1	30
11.	Keyboard Scan Codes, Set 1	30
12.	Keyboard Scan Codes, Set 2	31
13.	Keyboard Scan Codes, Set 2	32
14.	Keyboard Scan Codes, Set 2	33
15.	Keyboard Scan Codes, Set 2	33
16.	Keyboard Scan Codes, Set 2	33
17.	Keyboard Scan Codes, Set 3	34
18.	Keyboard Data Stream Bit Definitions	38
19.	Character Codes	41
20.	Special Character Codes	43
21.	Keyboard Extended Functions	44
22.	Keyboard Connectors Signal and Voltage Assignments	49

Notes:

Description

The keyboard has 102 keys (101 in the U.S.). At system power-on, the keyboard monitors the signals on the 'clock' and 'data' lines and establishes its line protocol. A bidirectional serial interface in the keyboard converts the 'clock' and 'data' signals and sends this information to and from the keyboard through the keyboard cable.

Keyboard Layouts

Keyboard layouts are in alphabetic order on the following pages. Nomenclature is on both the top and front face of the keybuttons.

- Belgian
- Canadian French
- Danish
- Dutch
- French
- German
- Italian
- Latin American
- Norwegian
- Portuguese
- Spanish
- Swedish
- Swiss
- U.K. English
- U.S. English.

Belgian Keyboard

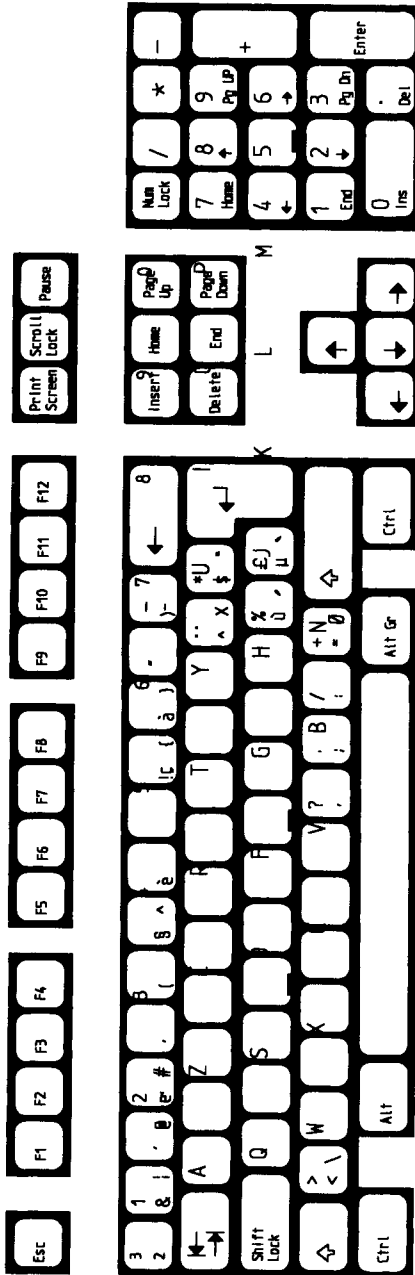

Canadian French Keyboard

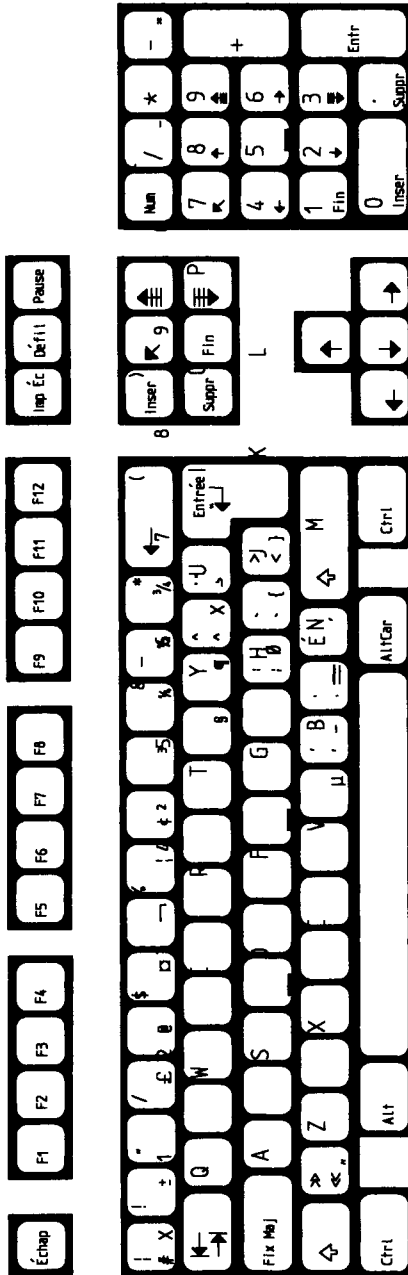

Danish Keyboard

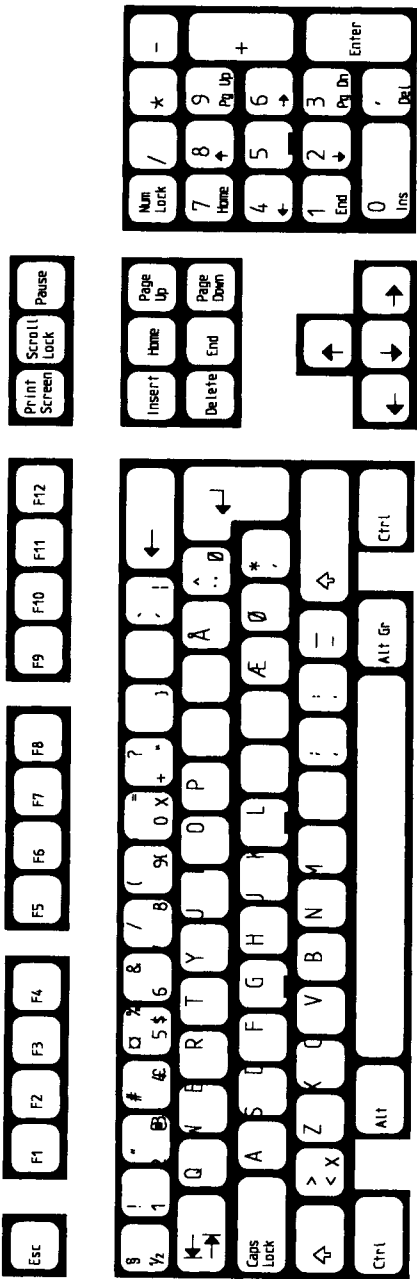

Dutch Keyboard

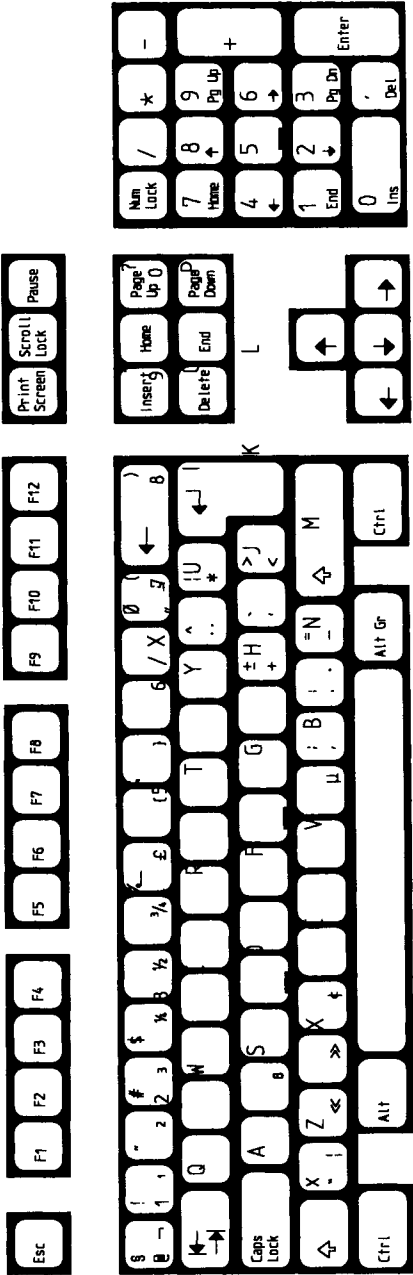

French Keyboard

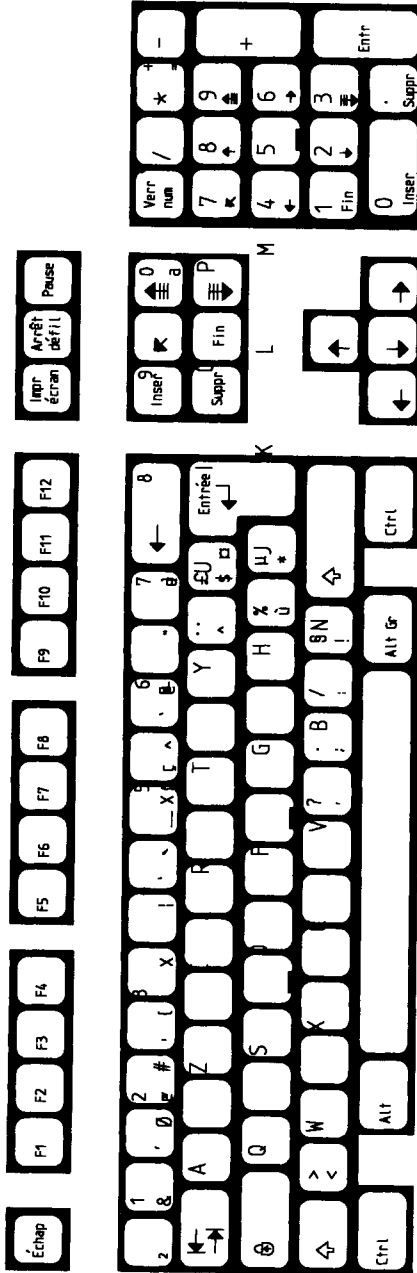

German Keyboard

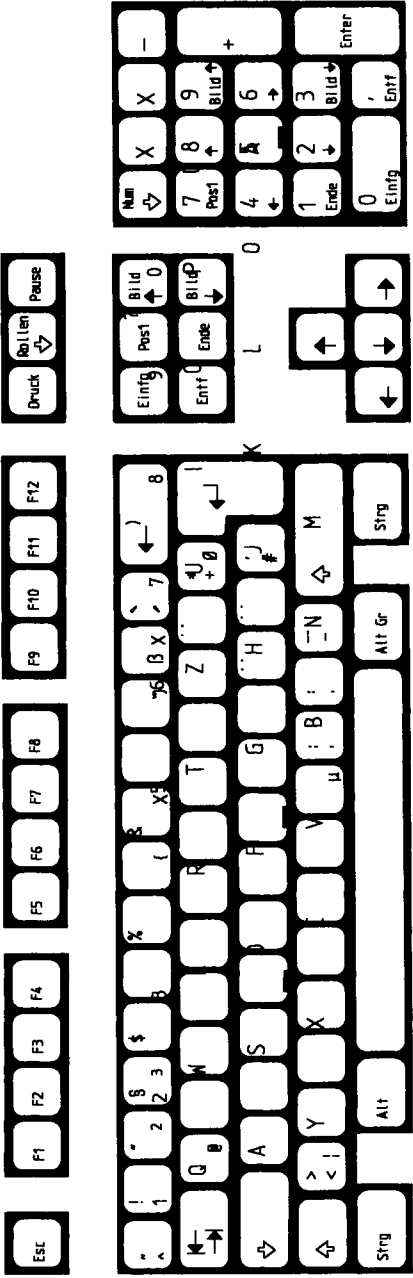

Portuguese Keyboard

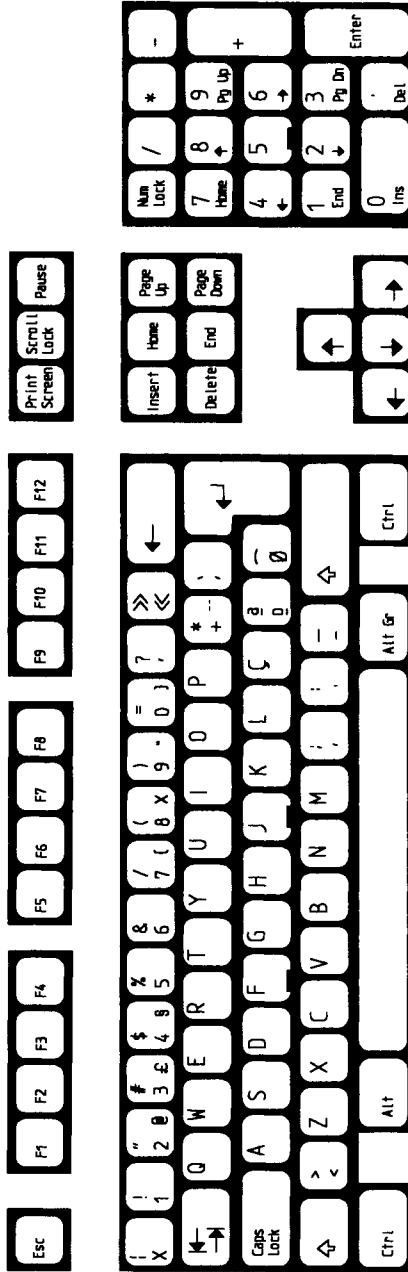

Spanish Keyboard

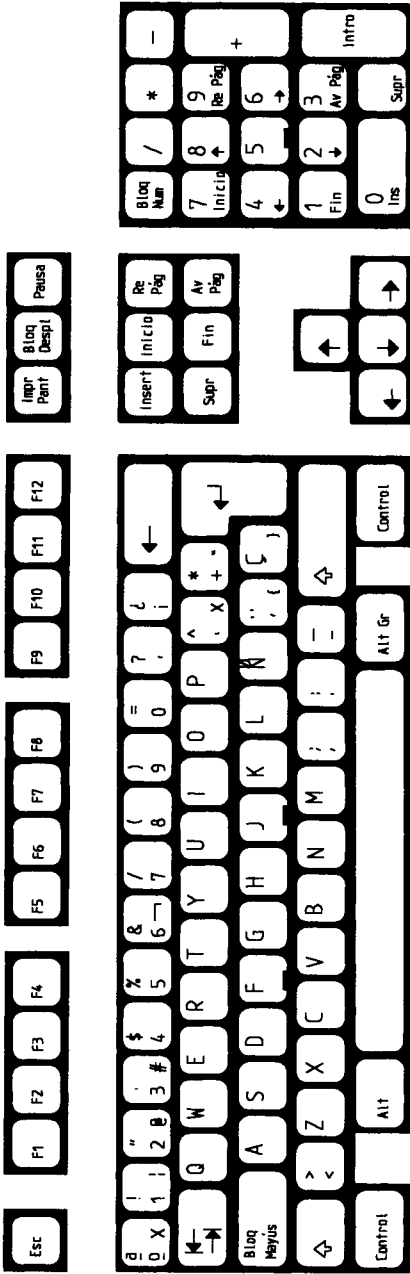

Swedish Keyboard

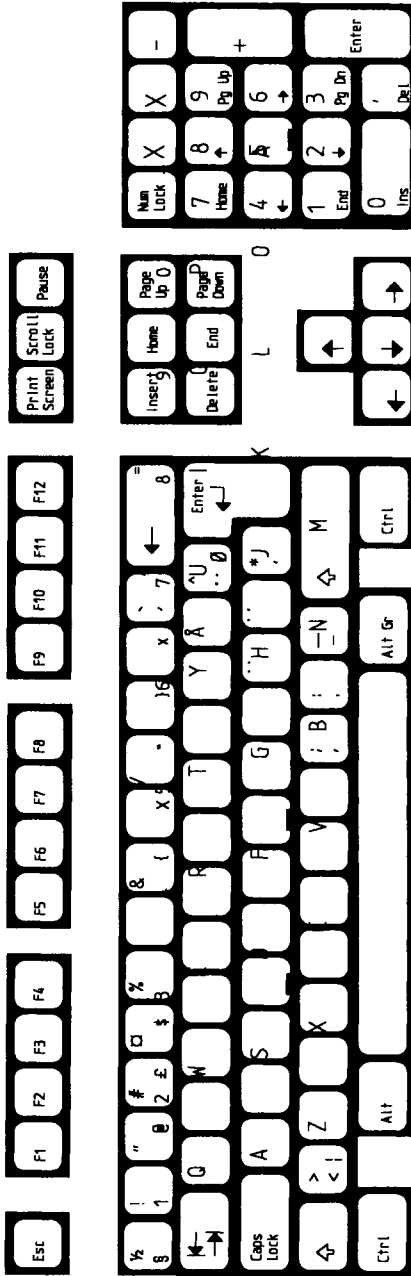

U.K. English Keyboard

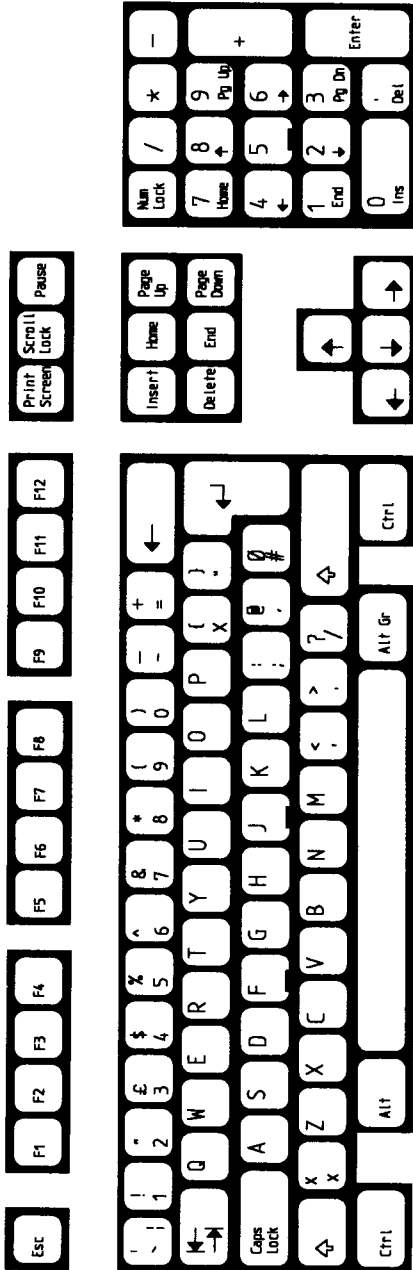

U.S. English Keyboard

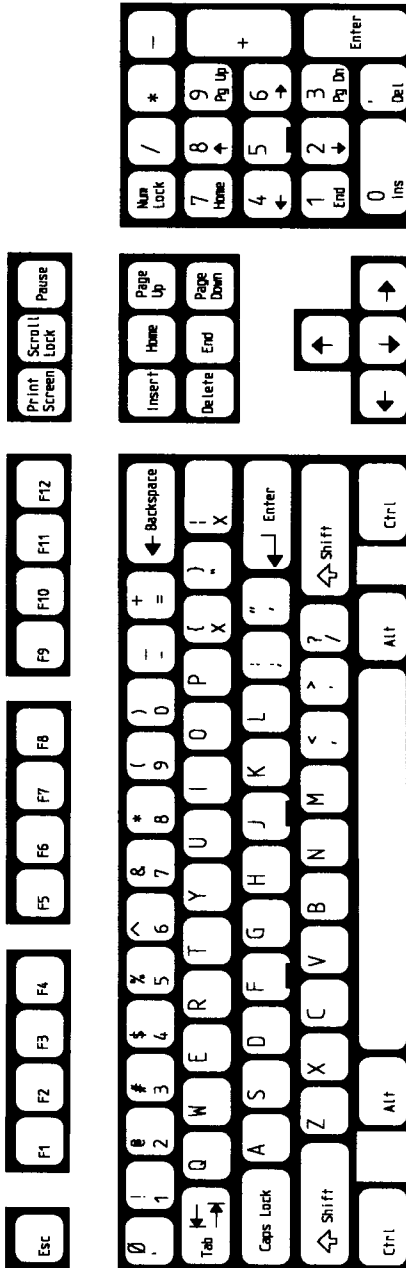

Sequential Key-Code Scanning

The keyboard detects all keys pressed and sends each scan code in the correct sequence. When not being serviced by the system, the keyboard stores the scan codes in its buffer.

Buffer

A 16-byte first-in-first-out (FIFO) buffer in the keyboard stores the scan codes until the system is ready to receive them. A buffer-overflow condition occurs when more than 16 bytes are placed in the keyboard buffer. An overflow code replaces the 17th byte. If more keys are pressed before the system allows keyboard output, the additional data is lost.

When the keyboard is allowed to send data, the bytes in the buffer are sent as in normal operation, and new data entered is detected and sent. Response codes do not occupy a buffer position.

If keystrokes generate a multiple-byte sequence, the entire sequence must fit into the available buffer space, or the keystroke is discarded and a buffer-overflow condition occurs.

Keys

Except for the Pause key, all keys are *make/break*. The make scan code of a key is sent to the keyboard controller when the key is pressed. When the key is released, its break scan code is sent.

Also, except for the Pause key, all keys are *typematic*. When a key is pressed and held down, the keyboard sends the make code for that key, delays 500 milliseconds $\pm 20\%$, and begins sending a make code for that key at a rate of 10.9 characters per second $\pm 20\%$. The typematic rate and delay can be modified (see "Set Typematic Rate/Delay (Hex F3)" on page 24).

If two or more keys are held down, only the last key pressed repeats at the typematic rate. Typematic operation stops when the last key pressed is released, even if other keys are still held down. If a key is pressed and held down while keyboard transmission is inhibited, only the first make code is stored in the buffer. This prevents buffer overflow caused by typematic action.

Note: Scan-code set 3 allows key types to be changed by the system. See "Set 3 Scan Code Tables" on page 34 for the default settings.

Power-On Routine

The following activities take place when power is first applied to the keyboard:

Power-On Reset (POR)

The keyboard logic generates a 'power-on reset' signal when power is first applied to the keyboard. A POR takes a minimum of 150 milliseconds and a maximum of 2.0 seconds from the time power is first applied to the keyboard.

Basic Assurance Test

The basic assurance test (BAT) consists of a keyboard processor test, a checksum of the read-only memory (ROM), and a random-access memory (RAM) test. During the BAT, activity on the 'clock' and 'data' lines is ignored. The LEDs are turned on at the beginning and off at the end of the BAT. The BAT takes a minimum of 300 milliseconds and a maximum of 500 milliseconds. This is in addition to the time required by the POR.

On satisfactory completion of the BAT, a completion code (hex AA) is sent to the system, and keyboard scanning begins. If a BAT failure occurs, the keyboard sends an error code to the system. The keyboard is then disabled pending command input. Completion codes are sent between 450 milliseconds and 2.5 seconds after the POR, and between 300 and 500 milliseconds after a Reset command is acknowledged.

Immediately following a POR, the keyboard monitors the signals on the keyboard 'clock' and 'data' lines and sets the line protocol.

Commands from the System

The following figure shows the commands that the system may send and their hexadecimal values.

Command	Hex Value
Set/Reset Status Indicators	ED
Echo	EE
Invalid Command	EF
Select Alternate Scan Codes	F0
Invalid Command	F1
Read ID	F2
Set Typematic Rate/Delay	F3
Enable	F4
Default Disable	F5
Set Default	F6
Set All Keys - Typematic	F7
- Make/Break	F8
- Make	F9
- Typematic/Make/Break	FA
Set Key Type - Typematic	FB
- Make/Break	FC
- Make	FD
Resend	FE
Reset	FF

Figure 1. Keyboard Commands from the System

These commands can be sent to the keyboard at any time. The keyboard responds within 20 milliseconds, except when performing the BAT or executing a Reset command.

Note: Mode 1 accepts only the Reset command.

The following commands are in alphabetic order. They have different meanings when issued by the keyboard (see "Commands to the System" on page 26).

Default Disable (Hex F5): The Default Disable command resets all conditions to the power-on default state. The keyboard responds with ACK, clears its output buffer, sets the default key types (scan-code set 3 operation only) and typematic rate/delay, and clears the last typematic key. The keyboard stops scanning and awaits further instructions.

Echo (Hex EE): Echo is a diagnostic aid. When the keyboard receives this command, it issues a hex EE response. If previously enabled, it continues scanning.

Enable (Hex F4): On receipt of this command, the keyboard responds with ACK, clears its output buffer, clears the last typematic key, and starts scanning.

Invalid Command (Hex EF and F1): Hex EF and hex F1 are invalid commands and are not supported. If one of these is sent, the keyboard does not acknowledge the command but returns a Resend command and continues in its prior scanning state. No other activities occur.

Read ID (Hex F2): This command requests identification information from the keyboard. The keyboard responds with ACK, stops scanning, and sends the two keyboard ID bytes. The second byte must follow completion of the first by no more than 500 microseconds. After the output of the second ID byte, the keyboard resumes scanning.

Resend (Hex FE): The system sends this command when it detects an error in any transmission from the keyboard. It is sent only after a keyboard transmission and before the system allows the next keyboard output. When a Resend command is received, the keyboard sends the previous output again (unless the previous output was the Resend command, in which case the keyboard sends the last byte before the Resend command).

Reset (Hex FF): The system issues a Reset command to start a program reset and a keyboard internal self-test. The keyboard acknowledges the command with an ACK and ensures the system accepts ACK before executing the command. The system signals acceptance of ACK by raising the 'clock' and 'data' lines for a minimum of 500 microseconds. The keyboard is disabled from the time it receives the Reset command until ACK is accepted, or until another command is sent that overrides the previous command.

Following acceptance of ACK, the keyboard is reinitialized and performs the BAT. After returning the completion code, the keyboard defaults to scan-code set 2.

Select Alternate Scan Codes (Hex F0): This command instructs the keyboard to select one of three sets of scan codes. The keyboard acknowledges receipt of this command with ACK and clears both the output buffer and the typematic key (if one is active). The system then sends the option byte and the keyboard responds with another ACK. An option byte value of hex 01 selects scan code set 1, hex 02 selects scan code set 2, and hex 03 selects scan code set 3.

An option byte value of hex 00 causes the keyboard to acknowledge with an ACK and send a byte telling the system which scan code set is currently in use. To prevent the controller from translating this byte, disable the keyboard-controller translate mode.

After establishing the new scan code set, the keyboard returns to the scanning state it was in before receiving the Select Alternate Scan Codes command.

Set All Keys (Hex F7, F8, F9, FA)

These commands instruct the keyboard to set all keys to a condition listed in the following figure.

Hex Value	Command
F7	Set All Keys - Typematic
F8	Set All Keys - Make/Break
F9	Set All Keys - Make
FA	Set All Keys - Typematic/Make/Break

Figure 2. Set All Keys Commands

The keyboard responds with ACK, clears its output buffer, sets all keys to the condition indicated by the command, and continues scanning (if it was previously enabled). Although these commands can be sent using any scan-code set, they affect only the operation of scan-code set 3.

Set Default (Hex F6): The Set Default command resets all conditions to the power-on default state. The keyboard responds with ACK, clears its output buffer, sets the default key types (scan-code set 3 operation only) and typematic rate/delay, clears the last typematic key, and continues scanning.

Set Key Type (Hex FB, FC, FD): These commands instruct the keyboard to set individual keys to a condition listed in the following figure.

Hex Value	Command
FB	Set Key Type - Typematic
FC	Set Key Type - Make/Break
FD	Set Key Type - Make

Figure 3. Set Key Type Commands

The keyboard responds with ACK, clears its output buffer, and prepares to receive key identification. The system identifies each key

by its scan-code value, as defined in scan-code set 3. Only scan code set 3 values are valid for key identification. The type of each identified key is set to the value indicated by the command.

These commands can be sent using any scan code set, but affect only the operation of scan code set 3.

Set/Reset Status Indicators (Hex ED): Three status indicators on the keyboard—Num Lock, Caps Lock, and Scroll Lock—are accessible by the system. The keyboard activates or deactivates these indicators when it receives a valid command-code sequence from the system. The command sequence begins with the command byte (hex ED). The keyboard responds with ACK, stops scanning, and waits for the option byte from the system. The bit assignments for this option byte are as follows.

Bit	Function
7 - 3	Reserved (must be 0's)
2	Caps Lock Indicator
1	Num Lock Indicator
0	Scroll Lock Indicator

Figure 4. Set/Reset Status Indicators

If a bit for an indicator is set to 1, the indicator is turned on. If a bit is set to 0, the indicator is turned off.

The keyboard responds to the option byte with ACK, sets the indicators and, if the keyboard was previously enabled, continues scanning. The state of the indicators reflects the bits in the option byte and can be activated or deactivated in any combination. If another command is received in place of the option byte, execution of the Set/Reset Mode Indicators command is stopped, with no change to the indicator states, and the new command is processed.

Immediately after power-on, the lights default to the Off state. If the Set Default and Default Disable commands are received, the lamps remain in the state they were in before the command was received.

Set Typematic Rate/Delay (Hex F3): The system issues this command to change the typematic rate and delay. The keyboard responds to the command with ACK, stops scanning, and waits for the system to issue the rate/delay value byte. The keyboard responds to the rate/delay value byte with another ACK, sets the rate and delay to the values indicated, and continues scanning (if it was previously enabled). Bits 6 and 5 indicate the delay, and bits 4, 3, 2, 1, and 0 (the

least-significant bit) indicate the rate. Bit 7, the most-significant bit, is always 0. The delay is determined by the following equation:

$$\text{Delay} = (1 + A) \times 250 \text{ milliseconds} \pm 20\%.$$

where:

$$A = \text{binary value of bits 5 and 6}$$

The period (interval from one typematic output to the next) is determined by the following equation:

$$\text{Period} = (8 + A) \times (2^B) \times 0.00417 \text{ seconds} \pm 20\%$$

where:

$$A = \text{binary value of bits 2, 1, and 0}$$

$$B = \text{binary value of bits 4 and 3}$$

The typematic rate (make codes per second) is 1 for each period.

Bit	Typematic Rate $\pm 20\%$	Bit	Typematic Rate $\pm 20\%$
00000	30.0	10000	7.5
00001	26.7	10001	6.7
00010	24.0	10010	6.0
00011	21.8	10011	5.5
00100	20.0	10100	5.0
00101	18.5	10101	4.6
00110	17.1	10110	4.3
00111	16.0	10111	4.0
01000	15.0	11000	3.7
01001	13.3	11001	3.3
01010	12.0	11010	3.0
01011	10.9	11011	2.7
01100	10.0	11100	2.5
01101	9.2	11101	2.3
01110	8.6	11110	2.1
01111	8.0	11111	2.0

Figure 5. Typematic Rate

The default values for the system keyboard are as follows:

$$\text{Typematic rate} = 10.9 \text{ characters per second} \pm 20\%$$

$$\text{Delay} = 500 \text{ milliseconds} \pm 20\%.$$

The execution of this command stops without change to the existing rate if another command is received instead of the rate/delay value byte.

Commands to the System

The following figure shows the commands that the keyboard can send to the system, and their hexadecimal values.

Command	Hex Value
Key Detection Error/Overrun	00 (Code Sets 2 and 3)
Keyboard ID	83AB
BAT Completion Code	AA
BAT Failure Code	FC
Echo	EE
Acknowledge (ACK)	FA
Resend	FE
Key Detection Error/Overrun	FF (Code Set 1)

Figure 6. Keyboard Commands to the System

The commands the keyboard sends to the system are described in alphabetic order. They have different meanings when issued by the system.

Acknowledge (Hex FA): The keyboard issues ACK to any valid input other than an Echo, or Resend command. If the keyboard is interrupted while sending ACK, it discards ACK and accepts and responds to the new command.

BAT Completion Code (Hex AA): Following satisfactory completion of the BAT, the keyboard sends hex AA. Any other code indicates a failure of the keyboard.

BAT Failure Code (Hex FC): If a BAT failure occurs, the keyboard sends this code, stops scanning, and waits for a system response or reset.

Echo (Hex EE): The keyboard sends this code in response to an Echo command.

Keyboard ID (Hex 83AB): The keyboard ID consists of two bytes, hex 83AB. The keyboard responds to the Read ID command with ACK, stops scanning, and sends the two ID bytes. The low byte is sent first followed by the high byte. Following the output of the keyboard ID, the keyboard begins scanning. Because of keyboard controller translation, the keyboard ID might not be returned to the system as hex 83AB.

Key Detection Error (Hex 00 or FF): The keyboard sends a key detection error character if conditions in the keyboard make it impossible to identify a switch closure. If the keyboard is using scan-code set 1, the code is hex FF. For sets 2 and 3, the code is hex 00.

Overrun (Hex 00 or FF): An overrun character is placed in the keyboard buffer and replaces the last code when the buffer capacity has been exceeded. The code is sent to the system when it reaches the top of the buffer queue. If the keyboard is using scan code set 1, the code is hex FF. For sets 2 and 3, the code is hex 00.

Resend (Hex FE): The keyboard issues a Resend command following receipt of an invalid input, or any input with incorrect parity. If the system sends nothing to the keyboard, no response is required.

Scan Codes

The following figures list the key numbers of the three scan code sets and their hexadecimal values. The system defaults to scan set 2, but can be switched to set 1 or set 3 (see “Select Alternate Scan Codes (Hex F0)” on page 22).

Set 1 Scan-Code Tables

In scan-code set 1, each key is assigned a base scan code and, sometimes, extra codes to generate artificial shift states in the system. The typematic scan codes are identical to the base scan code for each key.

The following figure shows the codes sent for the keys, regardless of any shift states in the keyboard or system. Refer to “Keyboard Layouts” beginning on page 1 to determine the character associated with each key number.

Key Number	Make Code	Break Code	Key Number	Make Code	Break Code
1	29	A9	47	2D	AD
2	02	82	48	2E	AE
3	03	83	49	2F	AF
4	04	84	50	30	B0
5	05	85	51	31	B1
6	06	86	52	32	B2
7	07	87	53	33	B3
8	08	88	54	34	B4
9	09	89	55	35	B5
10	0A	8A	57	36	B6
11	0B	8B	58	1D	9D
12	0C	8C	60	38	B8
13	0D	8D	61	39	B9
15	0E	8E	62	E0 38	E0 B8
16	0F	8F	64	E0 1D	E0 9D
17	10	90	90	45	C5
18	11	91	91	47	C7
19	12	92	92	4B	CB
20	13	93	93	4F	CF
21	14	94	96	48	C8
22	15	95	97	4C	CC
23	16	96	98	50	D0
24	17	97	99	52	D2
25	18	98	100	37	B7
26	19	99	101	49	C9
27	1A	9A	102	4D	CD
28	1B	9B	103	51	D1
*29	2B	AB	104	53	D3
30	3A	BA	105	4A	CA
31	1E	9E	106	4E	CE
32	1F	9F	108	E01C	E0 9C
33	20	A0	110	01	81
34	21	A1	112	3B	BB
35	22	A2	113	3C	BC
36	23	A3	114	3D	BD
37	24	A4	115	3E	BE
38	25	A5	116	3F	BF
39	26	A6	117	40	C0
40	27	A7	118	41	C1
41	28	A8	119	42	C2
** 42	2B	AB	120	43	C3
43	1C	9C	121	44	C4
44	2A	AA	122	57	D7
** 45	56	D6	123	58	D8
46	2C	AC	125	46	C6

Note: * 101-key keyboard only, ** 102-key keyboard only.

Figure 7. Keyboard Scan Codes, Set 1

The remaining keys send a series of codes that are dependent on the states of the various shift keys (Ctrl, Alt, and Shift), and the state of Num Lock (On or Off). Because the base scan code is identical to another key, an extra code (hex E0) has been added to the base code to make it unique.

Key No.	Base Case, or Shift + Num Lock Make/Break	Shift Case Make/Break *	Num Lock on Make/Break
75	E0 52 /E0 D2	E0 AA E0 52 /E0 D2 E0 2A	E0 2A E0 52 /E0 D2 E0 AA
76	E0 53 /E0 D3	E0 AA E0 53 /E0 D3 E0 2A	E0 2A E0 53 /E0 D3 E0 AA
79	E0 4B /E0 CB	E0 AA E0 4B /E0 CB E0 2A	E0 2A E0 4B /E0 CB E0 AA
80	E0 47 /E0 C7	E0 AA E0 47 /E0 C7 E0 2A	E0 2A E0 47 /E0 C7 E0 AA
81	E0 4F /E0 CF	E0 AA E0 4F /E0 CF E0 2A	E0 2A E0 4F /E0 CF E0 AA
83	E0 48 /E0 C8	E0 AA E0 48 /E0 C8 E0 2A	E0 2A E0 48 /E0 C8 E0 AA
84	E0 50 /E0 D0	E0 AA E0 50 /E0 D0 E0 2A	E0 2A E0 50 /E0 D0 E0 AA
85	E0 49 /E0 C9	E0 AA E0 49 /E0 C9 E0 2A	E0 2A E0 49 /E0 C9 E0 AA
86	E0 51 /E0 D1	E0 AA E0 51 /E0 D1 E0 2A	E0 2A E0 51 /E0 D1 E0 AA
89	E0 4D /E0 CD	E0 AA E0 4D /E0 CD E0 2A	E0 2A E0 4D /E0 CD E0 AA

Note: * If the left Shift key is held down, the AA/2A shift make and break are sent with the other scan codes. If the right Shift key is held down, B6/36 is sent. If both Shift keys are down, both sets of codes are sent with the other scan code.

Figure 8. Keyboard Scan Codes, Set 1

Key No.	Scan Code Make/Break	Shift Case Make/Break *
95	E0 35/E0 B5	E0 AA E0 35/E0 B5 E0 2A
Note: * If the left Shift key is held down, the AA/2A shift make and break are sent with the other scan codes. If the right Shift key is held down, B6/36 is sent. If both Shift keys are down, both sets of codes are sent with the other scan code.		

Figure 9. Keyboard Scan Codes, Set 1

Key No.	Scan Code Make/Break	Ctrl Case, Shift Case Make/Break	Alt Case Make/Break
124	E0 2A E0 37 /E0 B7 E0 AA	E0 37/E0 B7	54/D4

Figure 10. Keyboard Scan Codes, Set 1

Key No.	Make Code	Ctrl Key Pressed
126 *	E1 1D 45 E1 9D C5	E0 46 E0 C6
Note: * This key is not typematic. All associated scan codes occur on the make of the key.		

Figure 11. Keyboard Scan Codes, Set 1

Set 2 Scan-Code Tables

In scan-code set 2, each key is assigned a unique 8-bit make scan code, which is sent when the key is pressed. Each key also sends a break code when the key is released. The break code consists of 2 bytes, the first of which is the break code prefix, hex F0; the second byte is the same as the make scan code for that key. The typematic scan code for a key is the same as the key's make code.

The following figure shows the codes sent for the keys, regardless of any shift states in the keyboard or system. Refer to "Keyboard Layouts" beginning on page 1 to determine the character associated with each key number.

Key Number	Make Code	Break Code	Key Number	Make Code	Break Code
1	0E	F0 0E	47	22	F0 22
2	16	F0 16	48	21	F0 21
3	1E	F0 1E	49	2A	F0 2A
4	26	F0 26	50	32	F0 32
5	25	F0 25	51	31	F0 31
6	2E	F0 2E	52	3A	F0 3A
7	36	F0 36	53	41	F0 41
8	3D	F0 3D	54	49	F0 49
9	3E	F0 3E	55	4A	F0 4A
10	46	F0 46	57	59	F0 59
11	45	F0 45	58	14	F0 14
12	4E	F0 4E	60	11	F0 11
13	55	F0 55	61	29	F0 29
15	66	F0 66	62	E0 11	E0 F0 11
16	0D	F0 0D	64	E0 14	E0 F0 14
17	15	F0 15	90	77	F0 77
18	1D	F0 1D	91	6C	F0 6C
19	24	F0 24	92	6B	F0 6B
20	2D	F0 2D	93	69	F0 69
21	2C	F0 2C	96	75	F0 75
22	35	F0 35	97	73	F0 73
23	3C	F0 3C	98	72	F0 72
24	43	F0 43	99	70	F0 70
25	44	F0 44	100	7C	F0 7C
26	4D	F0 4D	101	7D	F0 7D
27	54	F0 54	102	74	F0 74
28	5B	F0 5B	103	7A	F0 7A
* 29	5D	F0 5D	104	71	F0 71
30	58	F0 58	105	7B	F0 7B
31	1C	F0 1C	106	79	F0 79
32	1B	F0 1B	108	E0 5A	E0 F0 5A
33	23	F0 23	110	76	F0 76
34	2B	F0 2B	112	05	F0 05
35	34	F0 34	113	06	F0 06
36	33	F0 33	114	04	F0 04
37	3B	F0 3B	115	0C	F0 0C
38	42	F0 42	116	03	F0 03
39	4B	F0 4B	117	0B	F0 0B
40	4C	F0 4C	118	83	F0 83
41	52	F0 52	119	0A	F0 0A
** 42	5D	F0 5D	120	01	F0 01
43	5A	F0 5A	121	09	F0 09
44	12	F0 12	122	78	F0 78
** 45	61	F0 61	123	07	F0 07
46	1A	F0 1A	125	7E	F0 7E

Note: * 101-key keyboard only, ** 102-key keyboard only.

Figure 12. Keyboard Scan Codes, Set 2

The remaining keys send a series of codes that are dependent on the state of the shift keys (Ctrl, Alt, and Shift), and the state of Num Lock (On or Off). Because the base scan code is identical to another key, an extra code (hex E0) is added to the base code to make it unique.

Key No.	Base Case, or Shift + Num Lock Make/Break	Shift Case Make/Break *	Num Lock on Make/Break
75	E0 70 /E0 F0 70	E0 F0 12 E0 70 /E0 F0 70 E0 12	E0 12 E0 70 /E0 F0 70 E0 F0 12
76	E0 71 /E0 F0 71	E0 F0 12 E0 71 /E0 F0 71 E0 12	E0 12 E0 71 /E0 F0 71 E0 F0 12
79	E0 6B /E0 F0 6B	E0 F0 12 E0 6B /E0 F0 6B E0 12	E0 12 E0 6B /E0 F0 6B E0 F0 12
80	E0 6C /E0 F0 6C	E0 F0 12 E0 6C /E0 F0 6C E0 12	E0 12 E0 6C /E0 F0 6C E0 F0 12
81	E0 69 /E0 F0 69	E0 F0 12 E0 69 /E0 F0 69 E0 12	E0 12 E0 69 /E0 F0 69 E0 F0 12
83	E0 75 /E0 F0 75	E0 F0 12 E0 75 /E0 F0 75 E0 12	E0 12 E0 75 /E0 F0 75 E0 F0 12
84	E0 72 /E0 F0 72	E0 F0 12 E0 72 /E0 F0 72 E0 12	E0 12 E0 72 /E0 F0 72 E0 F0 12
85	E0 7D /E0 F0 7D	E0 F0 12 E0 7D /E0 F0 7D E0 12	E0 12 E0 7D /E0 F0 7D E0 F0 12
86	E0 7A /E0 F0 7A	E0 F0 12 E0 7A /E0 F0 7A E0 12	E0 12 E0 7A /E0 F0 7A E0 F0 12
89	E0 74 /E0 F0 74	E0 F0 12 E0 74 /E0 F0 74 E0 12	E0 12 E0 74 /E0 F0 74 E0 F0 12

Note: * If the left Shift key is held down, the F0 12/12 shift make and break are sent with the other scan codes. If the right Shift key is held down, F0/59/59 is sent. If both Shift keys are down, both sets of codes are sent with the other scan code.

Figure 13. Keyboard Scan Codes, Set 2

Key No.	Scan Code Make/Break	Shift Case Make/Break *
95	E0 4A/E0 F0 4A	E0 F0 12 E0 4A/E0 F0 4A E0 12
<p>Note: * If the left Shift key is held down, the F0 12/12 shift make and break are sent with the other scan codes. If the right Shift key is held down, F0 59/59 is sent. If both Shift keys are down, both sets of codes are sent with the other scan code.</p>		

Figure 14. Keyboard Scan Codes, Set 2

Key No.	Scan Code Make/Break	Ctrl Case, Shift Case Make/Break	Alt Case Make/Break
124	E0 12 E0 7C /E0 F0 7C E0 F0 12	E0 7C/E0 F0 7C	84/F0 84

Figure 15. Keyboard Scan Codes, Set 2

Key No.	Make Code	Ctrl Key Pressed
126 *	E1 14 77 E1 F0 14 F0 77	E0 7E E0 F0 7E
<p>Note: * This key is not typematic. All associated scan codes occur on the make of the key.</p>		

Figure 16. Keyboard Scan Codes, Set 2

Set 3 Scan Code Tables

In scan-code set 3, each key is assigned a unique 8-bit make scan code, which is sent when the key is pressed. Each key also sends a break code when the key is released. The break code consists of two bytes, the first of which is the break-code prefix, hex F0; the second byte is the same as the make scan code for that key. The typematic scan code for a key is the same as the key's make code. With this scan-code set, each key sends only one scan code, and no keys are affected by the state of any other keys.

The following figure shows the codes sent for the keys, regardless of any shift states in the keyboard or system. Refer to "Keyboard Layouts" beginning on page 1 to determine the character associated with each key number.

Key Number	Make Code	Break Code	Default Key State
1	0E	F0 0E	Typematic
2	16	F0 16	Typematic
3	1E	F0 1E	Typematic
4	26	F0 26	Typematic
5	25	F0 25	Typematic
6	2E	F0 2E	Typematic
7	36	F0 36	Typematic
8	3D	F0 3D	Typematic
9	3E	F0 3E	Typematic
10	46	F0 46	Typematic
11	45	F0 45	Typematic
12	4E	F0 4E	Typematic
13	55	F0 55	Typematic
15	66	F0 66	Typematic
16	0D	F0 0D	Typematic
17	15	F0 15	Typematic
18	1D	F0 1D	Typematic
19	24	F0 24	Typematic
20	2D	F0 2D	Typematic
21	2C	F0 2C	Typematic
22	35	F0 35	Typematic
23	3C	F0 3C	Typematic
24	43	F0 43	Typematic
25	44	F0 44	Typematic
26	4D	F0 4D	Typematic
27	54	F0 54	Typematic
28	5B	F0 5B	Typematic
* 29	5C	F0 5C	Typematic
30	14	F0 14	Make/Break

Note: * 101-key keyboard only and ** 102-key keyboard only.

Figure 17 (Part 1 of 3). Keyboard Scan Codes, Set 3

Key Number	Make Code	Break Code	Default Key State
31	1C	F0 1C	Typematic
32	1B	F0 1B	Typematic
33	23	F0 23	Typematic
34	2B	F0 2B	Typematic
35	34	F0 34	Typematic
36	33	F0 33	Typematic
37	3B	F0 3B	Typematic
38	42	F0 42	Typematic
39	4B	F0 4B	Typematic
40	4C	F0 4C	Typematic
41	52	F0 52	Typematic
** 42	53	F0 53	Typematic
43	5A	F0 5A	Typematic
44	12	F0 12	Make/Break
** 45	13	F0 13	Typematic
46	1A	F0 1A	Typematic
47	22	F0 22	Typematic
48	21	F0 21	Typematic
49	2A	F0 2A	Typematic
50	32	F0 32	Typematic
51	31	F0 31	Typematic
52	3A	F0 3A	Typematic
53	41	F0 41	Typematic
54	49	F0 49	Typematic
55	4A	F0 4A	Typematic
57	59	F0 59	Make/Break
58	11	F0 11	Make/Break
60	19	F0 19	Make/Break
61	29	F0 29	Typematic
62	39	F0 39	Make only
64	58	F0 58	Make only
75	67	F0 67	Make only
76	64	F0 64	Typematic
79	61	F0 61	Typematic
80	6E	F0 6E	Make only
81	65	F0 65	Make only
83	63	F0 63	Typematic
84	60	F0 60	Typematic
85	6F	F0 6F	Make only
86	6D	F0 6D	Make only
89	6A	F0 6A	Typematic
90	76	F0 76	Make only
91	6C	F0 6C	Make only
92	6B	F0 6B	Make only
93	69	F0 69	Make only
95	77	F0 77	Make only
96	75	F0 75	Make only
97	73	F0 73	Make only
98	72	F0 72	Make only
99	70	F0 70	Make only
100	7E	F0 7E	Make only

Note: * 101-key keyboard only and ** 102-key keyboard only.

Figure 17 (Part 2 of 3). Keyboard Scan Codes, Set 3

Key Number	Make Code	Break Code	Default Key State
101	7D	F0 7D	Make only
102	74	F0 74	Make only
103	7A	F0 7A	Make only
104	71	F0 71	Make only
105	84	F0 84	Make only
106	7C	F0 7C	Typematic
108	79	F0 79	Make only
110	08	F0 08	Make only
112	07	F0 07	Make only
113	0F	F0 0F	Make only
114	17	F0 17	Make only
115	1F	F0 1F	Make only
116	27	F0 27	Make only
117	2F	F0 2F	Make only
118	37	F0 37	Make only
119	3F	F0 3F	Make only
120	47	F0 47	Make only
121	4F	F0 4F	Make only
122	58	F0 58	Make only
123	5E	F0 5E	Make only
124	57	F0 57	Make only
125	5F	F0 5F	Make only
126	62	F0 62	Make only

Note: * 101-key keyboard only and ** 102-key keyboard only.

Figure 17 (Part 3 of 3). Keyboard Scan Codes, Set 3

Clock and Data Signals

The keyboard and system communicate over the 'clock' and 'data' lines. The source of each of these lines is an open-collector device on the keyboard that allows either the keyboard or system to force a line to an inactive (low) level. When no communication is occurring, the 'clock' line is at an active (high) level. The state of the 'data' line is held active (high) by the keyboard.

When the system sends data to the keyboard, it forces the 'data' line to an inactive level and allows the 'clock' line to go to an active level.

An inactive signal has a value of at least 0 volts, but not more than +0.7 volts. A signal at the inactive level is a logical 0. An active signal has a value of at least +2.4 volts, but not more than +5.5 volts. A signal at the active level is a logical 1. Voltages are measured between a signal source and the dc network ground.

When the keyboard sends data to, or receives data from the system, it generates the 'clock' signal to time the data. The system can prevent the keyboard from sending data by forcing the 'clock' line to an inactive level; the 'data' line can be active or inactive during this time.

During the BAT, the keyboard allows the 'clock' and 'data' lines to go to an active level.

Data Stream

Data transmissions to and from the keyboard consist of an 11-bit data stream (Mode 2) sent serially over the 'data' line. The following figure shows the functions of the bits.

Bit	Function
11	Stop bit (always 1)
10	Parity bit (odd parity)
9	Data bit 7 (most-significant)
8	Data bit 6
7	Data bit 5
6	Data bit 4
5	Data bit 3
4	Data bit 2
3	Data bit 1
2	Data bit 0 (least-significant)
1	Start bit (always 0)

Figure 18. Keyboard Data Stream Bit Definitions

The parity bit is either 1 or 0, and the 8 data bits, plus the parity bit, always have an odd number of 1's.

Note: Mode 1 is a 9-bit data stream that does not have a parity bit or stop bit, and the start bit is always 1.

Data Output

When the keyboard is ready to send data, it first checks for a keyboard-inhibit or system request-to-send status on the 'clock' and 'data' lines. If the 'clock' line is inactive (low), data is stored in the keyboard buffer. If the 'clock' line is active (high) and the 'data' line is inactive (request-to-send), data is stored in the keyboard buffer, and the keyboard receives system data.

If the 'clock' and 'data' lines are both active, the keyboard sends the 0 start bit, 8 data bits, the parity bit, and the stop bit. Data is valid before the trailing edge and beyond the leading edge of the clock pulse. During transmission, the keyboard checks the 'clock' line for an active level at least every 60 milliseconds. If the system lowers the 'clock' line from an active level after the keyboard starts sending data, a condition known as *line contention* occurs, and the keyboard stops sending data. If line contention occurs before the leading edge of the 10th clock signal (parity bit), the keyboard buffer returns the 'clock' and 'data' lines to an active level. If contention does not occur by the 10th clock signal, the keyboard completes the transmission. Following line contention, the system may or may not request the keyboard to resend the data.

Following a transmission, the system can inhibit the keyboard until the system processes the input, or until it requests that a response be sent.

Data Input

When the system is ready to send data to the keyboard, it first checks to see if the keyboard is sending data. If the keyboard is sending, but has not reached the 10th 'clock' signal, the system can override the keyboard output by forcing the keyboard 'clock' line to an inactive (low) level. If the keyboard transmission is beyond the 10th 'clock' signal, the system must receive the transmission.

If the keyboard is not sending, or if the system elects to override the keyboard's output, the system forces the keyboard 'clock' line to an inactive level for more than 60 microseconds while preparing to send data. When the system is ready to send the start bit (the 'data' line will be inactive), it allows the 'clock' line to go to an active (high) level.

The keyboard checks the state of the 'clock' line at intervals of no more than 10 milliseconds. If a system request-to-send signal (RTS) is detected, the keyboard counts 11 bits. After the 10th bit, the keyboard checks for an active level on the 'data' line, and if the line is active, forces it inactive and counts one more bit. This action signals the system that the keyboard has received its data. On receipt of this signal, the system returns to a ready state, in which it can accept keyboard output, or goes to the inhibited state until it is ready.

If the keyboard 'data' line is found at an inactive level following the 10th bit, a framing error has occurred, and the keyboard continues to count until the 'data' line becomes active. The keyboard then makes the 'data' line inactive and sends a Resend command.

Each system command or data transmission to the keyboard requires a response from the keyboard before the system can send its next output. The keyboard will respond within 20 milliseconds unless the system prevents keyboard output. If the keyboard response is invalid or has a parity error, the system sends the command or data again. However, two-byte commands require special handling. If hex F3 (Set Typematic Rate/Delay), hex F0 (Select Alternate Scan Codes), or hex ED (Set/Reset Mode Indicators) have been sent and acknowledged, and the value byte has been sent but the response is invalid or has a parity error, the system resends both the command and the value byte.

Encode and Usage

The keyboard routine, provided in the ROM BIOS, is responsible for converting the keyboard scan codes into what is called *Extended ASCII*. The extended ASCII codes returned by the ROM routine are mapped to the U.S. English keyboard layout. Some operating systems might make provisions for alternate keyboard layouts by providing an interrupt replacement routine, which resides in the read/write memory. This section discusses only the ROM routine.

Extended ASCII encompasses one-byte character codes with possible values of 0 to 255, an extended code for certain extended keyboard functions, and functions handled within the keyboard routine or through interrupts.

The character codes are passed through the BIOS keyboard routine to the system or application program. In the following figure “-1” means the combination is suppressed in the keyboard routine. The codes are returned in the AL register.

Key	Base Case	Uppercase	Ctrl	Alt
1	‘	~	-1	(*)
2	1	!	-1	(*)
3	2	@	Null(000) (*)	(*)
4	3	#	-1	(*)
5	4	\$	-1	(*)
6	5	%	-1	(*)
7	6	^	RS(030)	(*)
8	7	&	-1	(*)
9	8	*	-1	(*)
10	9	(-1	(*)
11	0)	-1	(*)
12	-	_	US(031)	(*)
13	=	+	-1	(*)
15	Backspace (008)	Backspace (008)	Del(127)	(*)
16	→ (009)	← (*)	(*)	(*)
17	q	Q	DC1(017)	(*)
18	w	W	ETB(023)	(*)
19	e	E	ENQ(005)	(*)
20	r	R	DC2(018)	(*)
21	t	T	DC4(020)	(*)
22	y	Y	EM(025)	(*)
23	u	U	NAK(021)	(*)
24	i	I	HT(009)	(*)
25	o	O	SI(015)	(*)
26	p	P	DLE(016)	(*)
27	[{	Esc(027)	(*)
28]	}	GS(029)	(*)
29	\		FS(028)	(*)
30 Caps Lock	-1	-1	-1	-1
31	a	A	SOH(001)	(*)
32	s	S	DC3(019)	(*)
33	d	D	EOT(004)	(*)
34	f	F	ACK(006)	(*)
35	g	G	BEL(007)	(*)
36	h	H	BS(008)	(*)
37	j	J	LF(010)	(*)
38	k	K	VT(011)	(*)
39	l	L	FF(012)	(*)
40	;	:	-1	(*)

Note: (*) Refer to “Extended Functions” on page 43. (**) Refer to “Special Handling” on page 47.

Figure 19 (Part 1 of 2). Character Codes

Key	Base Case	Uppercase	Ctrl	Alt
41	'	"	-1	(*)
43	CR(013)	CR(013)	LF(010)	(*)
44 Shift (Left)	-1	-1	-1	-1
46	z	Z	SUB(026)	(*)
47	x	X	CAN(024)	(*)
48	c	C	ETX(003)	(*)
49	v	V	SYN(022)	(*)
50	b	B	STX(002)	(*)
51	n	N	SO(014)	(*)
52	m	M	CR(013)	(*)
53	.	<	-1	(*)
54	.	>	-1	(*)
55	/	?	-1	(*)
57 Shift (Right)	-1	-1	-1	-1
58 Ctrl (Left)	-1	-1	-1	-1
60 Alt (Left)	-1	-1	-1	-1
61	Space	Space	Space	Space
62 Alt (Right)	-1	-1	-1	-1
64 Ctrl (Right)	-1	-1	-1	-1
90 Num Lock	-1	-1	-1	-1
95	/	/	(*)	(*)
100	-	*	(*)	(*)
105	-	-	(*)	(*)
106	+	+	(*)	(*)
108	Enter	Enter	LF(010)	(*)
110	Esc	Esc	Esc	(*)
112	Null (*)	Null (*)	Null (*)	Null(*)
113	Null (*)	Null (*)	Null (*)	Null(*)
114	Null (*)	Null (*)	Null (*)	Null(*)
115	Null (*)	Null (*)	Null (*)	Null(*)
116	Null (*)	Null (*)	Null (*)	Null(*)
117	Null (*)	Null (*)	Null (*)	Null(*)
118	Null (*)	Null (*)	Null (*)	Null(*)
119	Null (*)	Null (*)	Null (*)	Null(*)
120	Null (*)	Null (*)	Null (*)	Null(*)
121	Null (*)	Null (*)	Null (*)	Null(*)
122	Null (*)	Null (*)	Null (*)	Null(*)
123	Null (*)	Null (*)	Null (*)	Null(*)
125 Scroll Lock	-1	-1	-1	-1
126	Pause(**)	Pause(**)	Break(**)	Pause(**)

Note: (*) Refer to "Extended Functions" on page 43. (**) Refer to "Special Handling" on page 47.

Figure 19 (Part 2 of 2). Character Codes

The following figure is a list of keys that have meaning only in Num Lock, Shift, or Ctrl states.

The Shift key temporarily reverses the current Num Lock state.

Key	Num Lock	Base Case	Alt	Ctrl
91	7	Home (*)	-1	Clear Screen
92	4	← (*)	-1	Reverse Word(*)
93	1	End (*)	-1	Erase to EOL(*)
96	8	↑ (*)	-1	(*)
97	5	(*)	-1	(*)
98	2	↓ (*)	-1	(*)
99	0	Ins	-1	(*)
101	9	Page Up (*)	-1	Top of Text and Home
102	6	→ (*)	-1	Advance Word (*)
103	3	Page Down (*)	-1	Erase to EOS (*)
104	.	Delete (*,**)	(**)	(**)
105	-	Sys Request	-1	-1
106	+	+ (*)	-1	-1

Note: (*) Refer to "Extended Functions." (**) Refer to "Special Handling" on page 47.

Figure 20. Special Character Codes

Extended Functions

For certain functions that cannot be represented by a standard ASCII code, an extended code is used. A character code of 000 (null) is returned in AL. This indicates that the system or application program should examine a second code, which indicates the actual function. Usually, but not always, this second code is the scan code of the primary key that was pressed. This code is returned in AH.

The following figure is a list of the extended codes and their functions.

Second Code	Function
1	Alt Esc
3	Null Character
14	Alt Backspace
15	← (Back-tab)
16-25	Alt Q, W, E, R, T, Y, U, I, O, P
26-28	Alt [] ←
30-38	Alt A, S, D, F, G, H, J, K, L
39-41	Alt ; ' ' ←
43	Alt \
44-50	Alt Z, X, C, V, B, N, M
51-53	Alt . , /
55	Alt Keypad *
59-68	F1 to F10 Function Keys (Base Case)
71	Home
72	↑ (Cursor Up)
73	Page Up
74	Alt Keypad -
75	← (Cursor Left)
76	Center Cursor
77	→ (Cursor Right)
78	Alt Keypad +
79	End
80	↓ (Cursor Down)
81	Page Down
82	Ins (Insert)
83	Del (Delete)
84-93	Shift F1 to F10
94-103	Ctrl F1 to F10
104-113	Alt F1 to F10
114	Ctrl PrtSc (Start/Stop Echo to Printer)
115	Ctrl ← (Reverse Word)
116	Ctrl → (Advance Word)
117	Ctrl End (Erase to End of Line-EOL)
118	Ctrl PgDn (Erase to End of Screen-EOS)
119	Ctrl Home (Clear Screen and Home)
120-131	Alt 1, 2, 3, 4, 5, 6, 7, 8, 9, 0, -, = keys 2-13
132	Ctrl PgUp (Top 25 Lines of Text and Cursor Home)
133-134	F11, F12
135-136	Shift F11, F12
137-138	Ctrl F11, F12
139-140	Alt F11, F12

Figure 21 (Part 1 of 2). Keyboard Extended Functions

Second Code	Function
141	Ctrl Up/8
142	Ctrl Keypad -
143	Ctrl Keypad 5
144	Ctrl Keypad +
145	Ctrl Down/2
146	Ctrl Ins/0
147	Ctrl Del/.
148	Ctrl Tab
149	Ctrl Keypad /
150	Ctrl Keypad *
151	Alt Home
152	Alt Up
153	Alt Page Up
155	Alt Left
157	Alt Right
159	Alt End
160	Alt Down
161	Alt Page Down
162	Alt insert
163	Alt Delete
164	Alt Keypad /
165	Alt Tab
166	Alt Enter

Figure 21 (Part 2 of 2). Keyboard Extended Functions

Shift States

Most shift states are handled within the keyboard routine and are not apparent to the system or application program. In any case, the current status of active shift states is available by calling an entry point in the BIOS keyboard routine. The following keys result in altered shift states:

Shift: This key temporarily shifts keys 1 through 13, 16 through 29, 31 through 41, and 46 through 55 to uppercase (base case if in Caps Lock state). Also, the Shift key temporarily reverses the Num Lock or non-Num Lock state of keys 91 through 93, 96, 98, 99, and 101 through 104.

Ctrl: This key temporarily shifts keys 3, 7, 12, 15 through 29, 31 through 39, 43, 46 through 52, 75 through 89, 91 through 93, 95 through 108, 112 through 124, and 126 to the Ctrl state. The Ctrl key is also used with the Alt and Del keys to initiate the system-reset function, with the Scroll Lock key to initiate the break function, and with the Num Lock key to initiate the pause function. The system-reset, break, and pause functions are described under "Special Handling" on page 47.

Alt: This key temporarily shifts keys 1 through 29, 31 through 43, 46 through 55, 75 through 89, 95, 100, and 105 through 124 to the Alt state. The Alt key is also used with the Ctrl and Del keys to cause a system reset.

The Alt key also allows the user to enter any character code from 1 to 255. The user holds down the Alt key and types the decimal value of the characters desired on the numeric keypad (keys 91 through 93, 96 through 99, and 101 through 103). The Alt key is then released. If the number is greater than 255, a modulo-256 value is used. This value is interpreted as a character code and is sent through the keyboard routine to the system or application program. Alt is handled internally in the keyboard routine.

Caps Lock: This key shifts keys 17 through 26, 31 through 39, and 46 through 52 to uppercase. When Caps Lock is pressed again, it reverses the action. Caps Lock is handled internally in the keyboard routine. When Caps Lock is pressed, it changes the Caps Lock mode indicator. If the indicator was on, it goes off; if it was off, it goes on.

Scroll Lock: When interpreted by appropriate application programs, this key indicates that the cursor-control keys will cause windowing over the text rather than moving the cursor. When the Scroll Lock key is pressed again, it reverses the action. The keyboard routine simply records the current shift state of the Scroll Lock key. It is the responsibility of the application program to perform the function. When Scroll Lock is pressed, it changes the Scroll Lock mode indicator. If the indicator was on, it goes off; if it was off, it goes on.

Num Lock: This key shifts keys 91 through 93, 96 through 99, and 101 through 104 to uppercase. When Num Lock is pressed again, it reverses the action. Num Lock is handled internally in the keyboard routine. When Num Lock is pressed, it changes the Num Lock mode indicator. If the indicator was on, it goes off; if it was off, it goes on.

Shift Key Priorities and Combinations: If combinations of the Alt, Ctrl, and Shift keys are pressed and only one is valid, the priority is: Alt key first, Ctrl key second, and Shift key third. The only valid combination is Alt and Ctrl, which is used in the system-reset function.

Special Handling

System Reset

The combination of Alt, Ctrl, and Del keys results in the keyboard routine that starts a system reset or restart. System reset is handled by system BIOS.

Break

The combination of the Ctrl and Pause/Break keys results in the keyboard buffer being cleared. The keyboard routine then signals interrupt 1B, and the extended characters AL = hex 00, and AH = hex 00 are stored in the buffer.

Pause

The Pause key causes the keyboard interrupt routine to loop, waiting for any character or function key to be pressed. This provides a method of temporarily suspending an operation, such as listing or printing, and then resuming the operation. The method is not apparent to either the system or the application program. The key stroke used to resume operation is discarded. Pause is handled internally in the keyboard routine.

Print Screen

The Print Screen key results in an interrupt invoking the print-screen routine. This routine works in the alphanumeric or graphics mode, with unrecognizable characters causing blanks.

System Request

When the System Request (Alt and Print Screen) key is pressed, a hex 8500 is placed in AX, and an interrupt hex 15 is executed. When the System Request key is released, a hex 8501 is placed in AX, and another interrupt hex 15 is executed. If an application is to use System Request, the following rules must be observed:

Save the previous address.

Overlay interrupt vector hex 15.

Check AH for a value of hex 85:

If yes, process may begin.

If no, go to previous address.

The application program must preserve the value in all registers, except AX, on return. System Request is handled internally in the keyboard routine.

Other Characteristics

The keyboard routine does its own buffering, and the keyboard buffer is large enough to support entries by a fast typist. However, if a key is pressed when the buffer is full, the key is ignored and the alarm sounds.

The keyboard routine also suppresses the typematic action of the following keys: Ctrl, Shift, Alt, Num Lock, Scroll Lock, Caps Lock, and Ins.

During each interrupt hex 09 from the keyboard, an interrupt hex 15, function (AH) = hex 4F is generated by the BIOS after the scan code is read from the keyboard adapter. The scan code is passed in the AL register with the carry flag set. This allows an operating system to intercept each scan code before it is handled by the interrupt hex 09 routine and change or act on the scan code. If the carry flag is changed to 0 on return from interrupt hex 15, the scan code is ignored by the interrupt handler.

Cables and Connectors

The keyboard cable connects to the system with a 6-pin miniature DIN connector and to the keyboard with a 6-position connector. The following figures show the pin configuration and signal assignments.

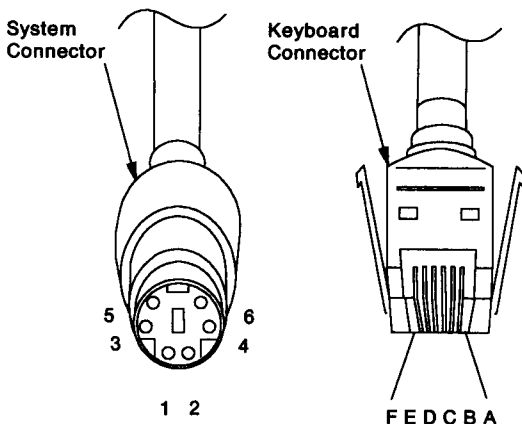

DIN Connector Pins	Signal Name	Keyboard Connector Pins
1	+KBD DATA	B
2	Reserved	F
3	Ground	C
4	+5.0 Vdc	E
5	+KBD CLK	D
6	Reserved	A
Shield	Frame Ground	Shield

Figure 22. Keyboard Connectors Signal and Voltage Assignments

Specifications

Specifications for the keyboard are as follows:

Power Requirements

- +5 Vdc \pm 10%
- 275 mA.

Size

- Length: 492 millimeters (19.4 inches)
- Depth: 210 millimeters (8.3 inches)
- Height: 58 millimeters (2.3 inches), legs extended.

Weight

- 2.25 kilograms (5.0 pounds).